

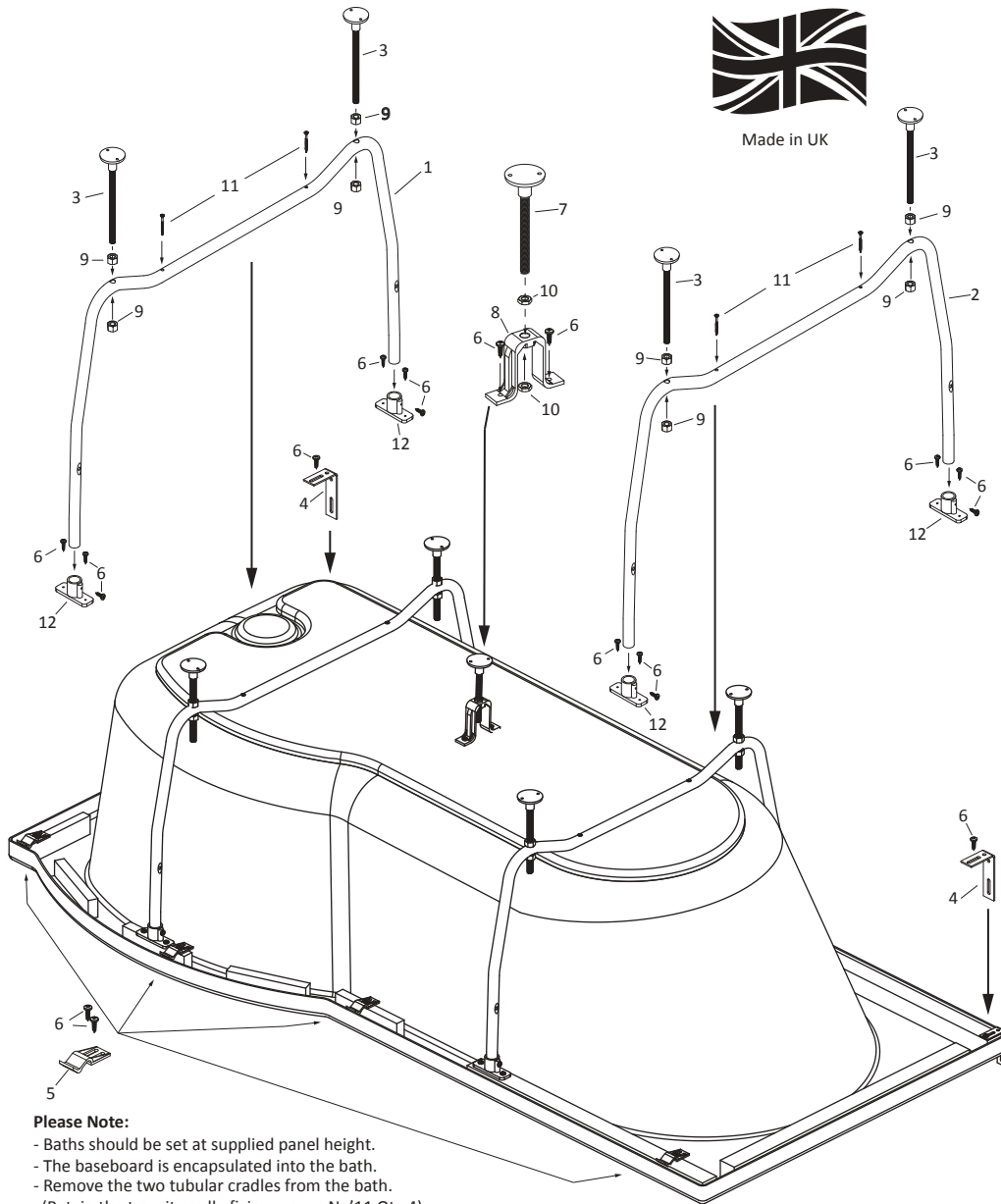

Made in UK



Please Note:

- Baths should be set at supplied panel height.
- The baseboard is encapsulated into the bath.
- Remove the two tubular cradles from the bath.
(Retain the transit cradle fixing screws No'11 Qty 4)
- Align the cradle and hand screw directly into the base of the bath using the transit cradle fixing screws.
(Important! YOU MUST CHECK THE SCREW LENGTH FIRST)
- Half the panel clips supplied should be secured (if possible) to the floor.
- Panel clips are not required on double ended baths.
- Before the final fixing of the bath, fit tap and waste fittings using a suitable sealing compound. When complete place the bath into position, re-check levels and make any final adjustments necessary. Finally secure the feet to the floor and the wall brackets to the wall. Movement may occur if not fitted correctly.
- CHECK THAT THE BATH RIM IS LEVEL.

Quality Acrylic Baths

Manufactured in the UK

**P Shape Bath
Installation Instructions**

- Read through the instruction booklet first before commencing any work.
If you are unsure of any aspect of the installation, we recommend you contact a reputable tradesperson.
- Prior to fitting your bath, carefully remove all the packaging and film from the bath and examine the bath for damage and suitability of colour match.
- Check the panel fit and match prior to installation.
- Any refixing costs or claims for wrong colour match and/or any other fault will not be accepted after fixing.

No claims for the above will be accepted once the bath is fitted.

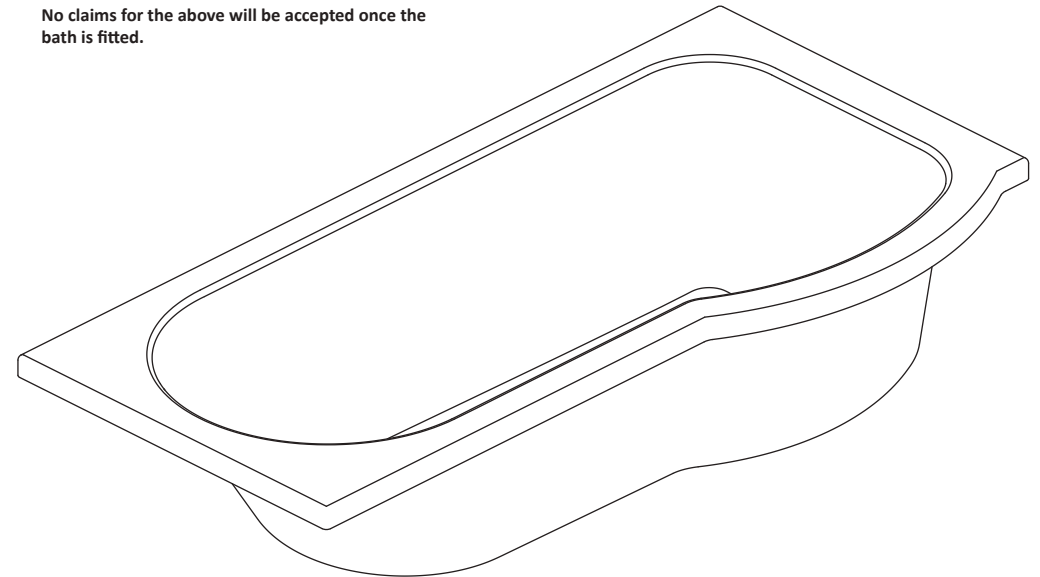

Please note, RH P-Shape bath shown for illustrational purposes.

25
Year
Guarantee

P Shape Bath

Installation Instructions

Before you start

- Before fixing remove ALL protective covering and examine carefully. The polythene film must be removed in full and the bath checked for any visible damage.
- Unpack and check the product is complete and undamaged.
- Have the correct tools available.
- Please notify the retailer immediately of any damage or faults. The manufacturer cannot be held responsible for any installation costs that may arise from damaged or faulty product being installed. The guarantee does not cover impact related damage. Please dispose of all packaging with due regard to the environment.

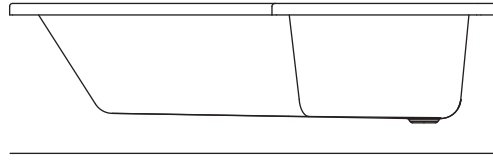

Safety

- Handle the bath with care.
- This product is heavy and requires two persons to carry.
- When drilling walls, check first for hidden pipes and cables.
- Use safety eyewear when drilling.
- Keep small parts away from children.

Tools required

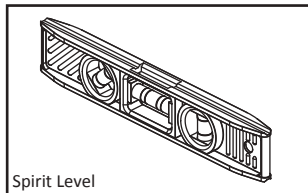

Spirit Level

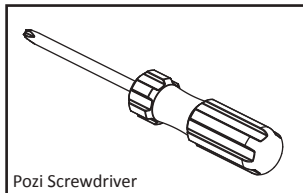

Pozi Screwdriver

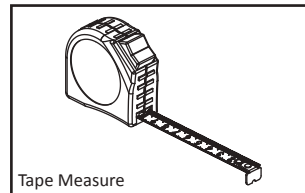

Tape Measure

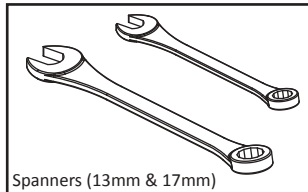

Spanners (13mm & 17mm)

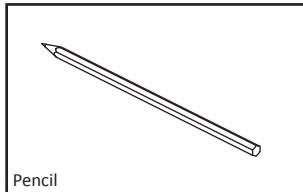

Pencil

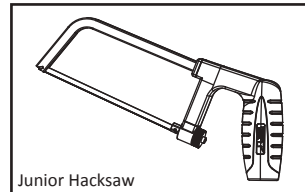

Junior Hacksaw

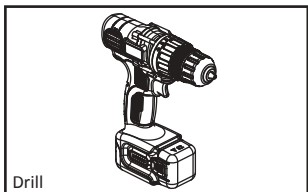

Drill

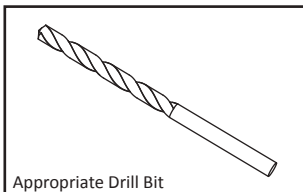

Appropriate Drill Bit

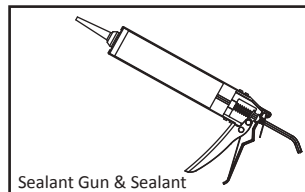

Sealant Gun & Sealant

*Tools shown not supplied

*Ensure drill bit used is suitable for wall surface!

Parts provided

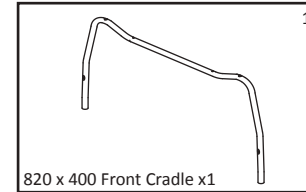

820 x 400 Front Cradle x1

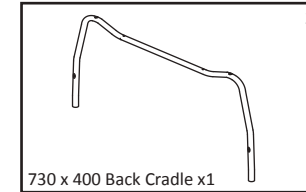

730 x 400 Back Cradle x1

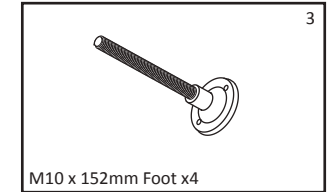

M10 x 152mm Foot x4

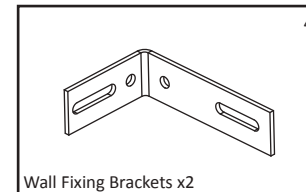

Wall Fixing Brackets x2

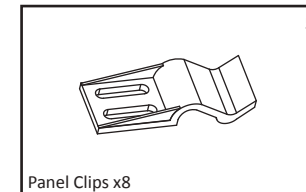

Panel Clips x8



16mm Self Tapping Screws x32

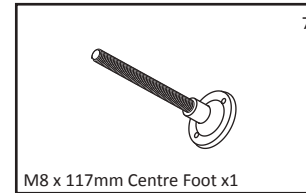

M8 x 117mm Centre Foot x1

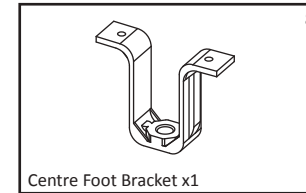

Centre Foot Bracket x1

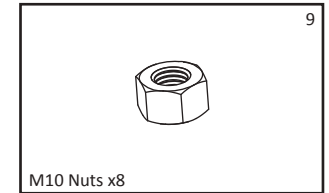

M10 Nuts x8

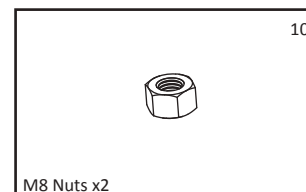

M8 Nuts x2

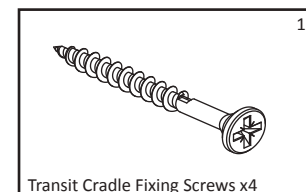

Transit Cradle Fixing Screws x4

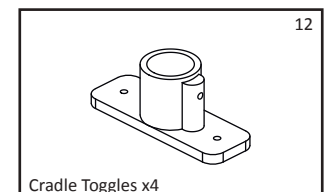

Cradle Toggles x4

- We have taken great care to ensure that this product reaches you in perfect condition. However should any parts be damaged or missing please contact your point of purchase. This does not affect your statutory rights. In addition if you require replacement parts your point of purchase will be happy to assist.

- You may have additional spare parts, please discard with due regard to the environment.